

Moulding Scribe

- MSW8** (1 - 8' pcs)
- MSW16** (2 - 8' pcs)
- MSW24** (3 - 8' pcs)
- MSW32** (4 - 8' pcs)
- MSW40** (5 - 8' pcs)
- MSW48** (6 - 8' pcs)
- MSW200** (25 - 8' pcs)

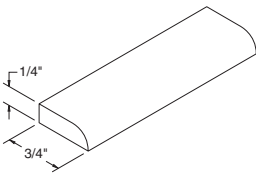

Moulding Outside Corner

90°

- MOCW8** (1 - 8' pcs)
- MOCW16** (2 - 8' pcs)
- MOCW24** (3 - 8' pcs)
- MOCW32** (4 - 8' pcs)
- MOCW40** (5 - 8' pcs)
- MOCW48** (6 - 8' pcs)
- MOCW200** (25 - 8' pcs)

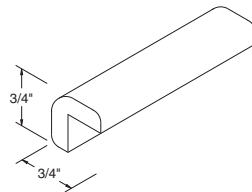

NOTES ✓

- ▶ Moulding Scribe dimension: 1/4" x 3/4" x 8'.
- ▶ Moulding Outside Corner dimension: 3/4" x 3/4" x 8'.

DESIGN SOLUTIONS

- ▶ Use the Moulding Outside Corner to create a finished look on ends of cabinet runs.



Moulding Outside Corner

135°

- MOC135-8** (1 - 8' pcs)

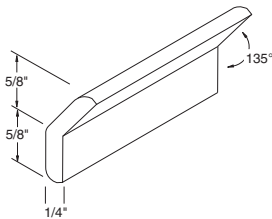

Moulding Triple Bead

- MTBEAD8** (1 - 8' pcs)
- MTBEAD16** (2 - 8' pcs)
- MTBEAD24** (3 - 8' pcs)

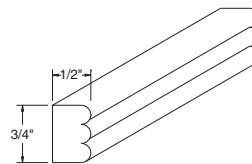

NOTES ✓

- ▶ Moulding Outside Corner dimension: 5/8" x 5/8" x 8'.
- ▶ Moulding Triple Bead dimension: 3/4" x 1/2" x 8'.

DESIGN SOLUTIONS

- ▶ Use the Moulding Outside Corner to create a finished look on ends of cabinet runs.
- ▶ MTBEAD can be used with Insert Crown Moulding.



Moulding Crown

Crown – Wood

- MCROWN8** (1 - 8' pcs)
- MCROWN16** (2 - 8' pcs)
- MCROWN24** (3 - 8' pcs)

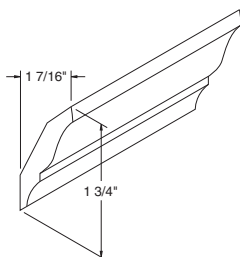

Crown – Insert

- MICROWN8** (1 - 8' pcs)
- MICROWN16** (2 - 8' pcs)
- MICROWN24** (3 - 8' pcs)

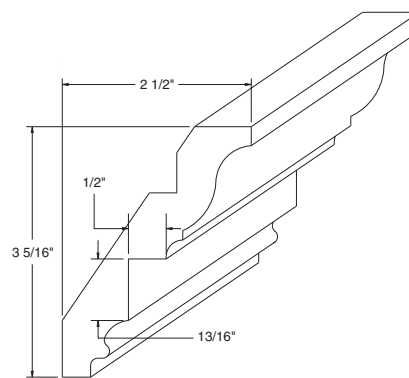

NOTES ✓

- ▶ Moulding Crown dimension: 1 7/16" x 1 3/4" x 8'.
- ▶ Moulding Crown Insert dimension: 3 5/16" x 2 1/2" x 8'.

DESIGN SOLUTIONS

- ▶ For Moulding Solutions, see pages 44 & 45.
- ▶ Remember to order extra Mouldings when working with mitered corners.
- ▶ MICROWN is designed for inserts (i.e. dentil, rope, triple bead.)
- ▶ At minimum, leave a 3" reveal at the end of a run to allow Moulding and countertop ample clearance to return back to the wall.



NOTES ✓

- ▶ Moulding Full Overlay Crown dimension: 1 3/4" x 1 3/4" x 8'.
- ▶ Moulding Tall Crown dimension: 2 3/8" x 3 17/32" x 8'.

DESIGN SOLUTIONS

- ▶ For Moulding Solutions, see pages 44 & 45.
- ▶ Remember to order extra Mouldings when working with mitered corners.
- ▶ At minimum, leave a 3" reveal at the end of a run to allow Moulding and countertop ample clearance to return back to the wall.



Moulding Crown (continued)

Crown – Full Overlay

- MFOLCR8** (1 - 8' pcs)
- MFOLCR16** (2 - 8' pcs)
- MFOLCR24** (3 - 8' pcs)

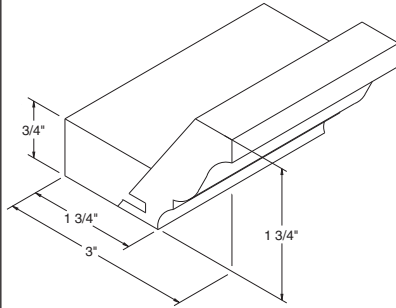

Crown – Tall

- MTCROWN8** (1 - 8' pcs)

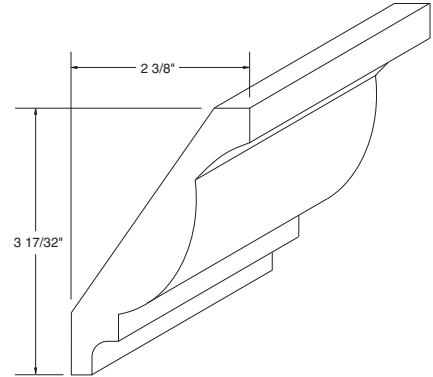

NOTES ✓

- ▶ Moulding Shaker Crown dimension: 2 19/32" x 2" x 8'.
- ▶ MSHKRCROWN available in maple finishes only.
- ▶ Moulding Counter Top dimension: 3/4" x 1 1/2" x 8'.

DESIGN SOLUTIONS

- ▶ For Moulding Solutions, see pages 44 & 45.
- ▶ Remember to order extra Mouldings when working with mitered corners.
- ▶ At minimum, leave a 3" reveal at the end of a run to allow Moulding and countertop ample clearance to return back to the wall.



Moulding Crown (continued)

Crown – Shaker

- MSHKRCROWN8** (1 - 8' pcs)
- MSHKRCROWN16** (2 - 8' pcs)
- MSHKRCROWN24** (3 - 8' pcs)

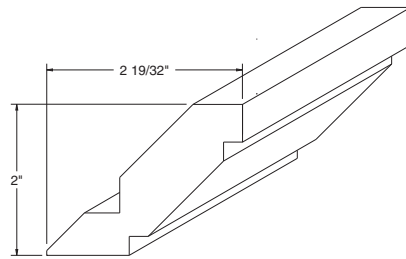

Moulding Counter Top

Radius

- MCTR8** (1 - 8' pcs)
- MCTR16** (2 - 8' pcs)
- MCTR24** (3 - 8' pcs)

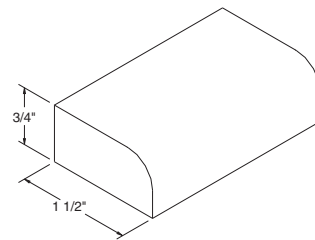

NOTES ✓

- ▶ Moulding Counter Top dimension: 3/4" x 1 1/2" x 8'.

DESIGN SOLUTIONS

- ▶ MCTB can be flipped upside-down and used as top trim.



Moulding Counter Top (continued)

Bevel

- MCTB8** (1 - 8' pcs)
- MCTB16** (2 - 8' pcs)
- MCTB24** (3 - 8' pcs)

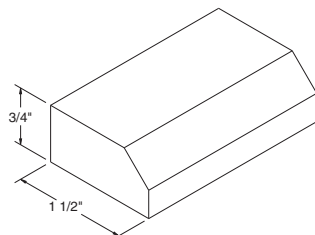

Ogee

- MCTOG8** (1 - 8' pcs)
- MCTOG16** (2 - 8' pcs)
- MCTOG24** (3 - 8' pcs)

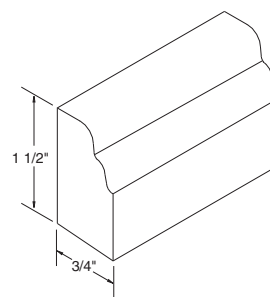

Moulding Cove

- MCV8** (1 - 8' pcs)
- MCV16** (2 - 8' pcs)
- MCV24** (3 - 8' pcs)
- MCV32** (4 - 8' pcs)
- MCV40** (5 - 8' pcs)
- MCV48** (6 - 8' pcs)
- MCV200** (25 - 8' pcs)

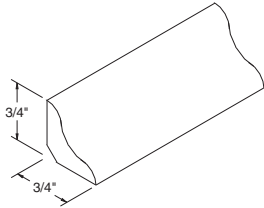

Moulding Quarter Round

- MQR8** (1 - 8' pcs)
- MQR16** (2 - 8' pcs)
- MQR24** (3 - 8' pcs)
- MQR32** (4 - 8' pcs)
- MQR40** (5 - 8' pcs)
- MQR48** (6 - 8' pcs)
- MQR200** (25 - 8' pcs)

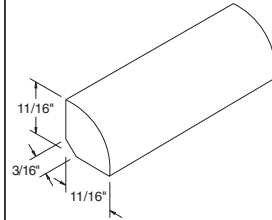

NOTES ✓

- ▶ Moulding Cove dimension: 3/4" x 3/4" x 8'.
- ▶ Moulding Quarter Round dimension: 11/16" x 11/16" x 8'.



Moulding Batten

- MBAT8** (1 - 8' pcs)
- MBAT16** (2 - 8' pcs)
- MBAT24** (3 - 8' pcs)
- MBAT32** (4 - 8' pcs)
- MBAT40** (5 - 8' pcs)
- MBAT48** (6 - 8' pcs)

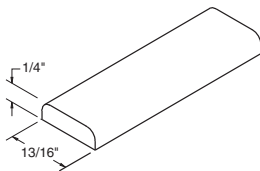

Moulding Traditional Soffit Trim

- MTST8** (1 - 8' pcs)
- MTST16** (2 - 8' pcs)
- MTST24** (3 - 8' pcs)

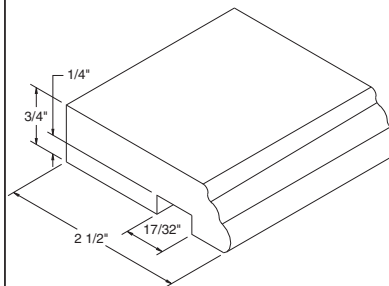

NOTES ✓

- ▶ Moulding Batten dimension: 1/4" x 13/16" x 8'.
- ▶ Moulding Traditional Soffit dimension: 2 1/2" x 3/4" x 8'.



Moulding Traditional Cap

- MTCAP8** (1 - 8' pcs)
- MTCAP16** (2 - 8' pcs)
- MTCAP24** (3 - 8' pcs)

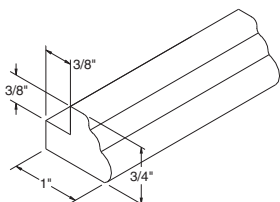

Moulding Tall Light Rail

- MTLR8** (1 - 8' pcs)
- MTLR16** (2 - 8' pcs)
- MTLR24** (3 - 8' pcs)

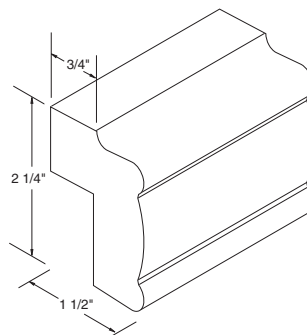

NOTES ✓

- ▶ Moulding Traditional Cap dimension: 3/4" x 1" x 8'.
- ▶ Moulding Tall Light Rail dimension: 2 1/4" x 1 1/2" x 8'.

DESIGN SOLUTIONS

- ▶ MTCAP can be flipped upside-down and used as a base piece for a stacked top trim.



NOTES ✓

- ▶ Moulding Light Rail dimension: 3/4" x 1 1/4" x 8'.
- ▶ Moulding Traditional Trim dimension: 3/4" x 3/4" x 8'.



Moulding Light Rail

- MLR8** (1 - 8' pcs)
- MLR16** (2 - 8' pcs)
- MLR24** (3 - 8' pcs)

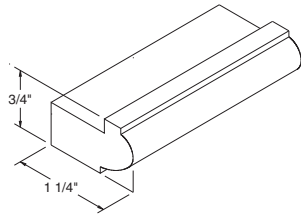

Moulding Traditional Trim

- MTT8** (1 - 8' pcs)
- MTT16** (2 - 8' pcs)
- MTT24** (3 - 8' pcs)

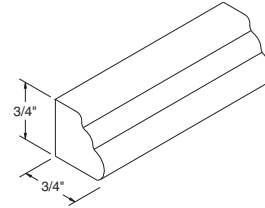

NOTES ✓

- ▶ Moulding Traditional Batten dimension: 5/16" x 3/4" x 8'.
- ▶ Moulding Dentil dimension: 1/2" x 3/4" x 8'.

DESIGN SOLUTIONS

- ▶ MTBAT and MDENTIL can be used with Insert Crown Moulding.



Moulding Traditional Batten

- MTBAT8** (1 - 8' pcs)
- MTBAT16** (2 - 8' pcs)
- MTBAT24** (3 - 8' pcs)

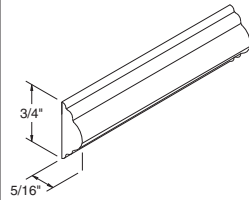

Moulding Dentil

- MDENTIL8** (1 - 8' pcs)
- MDENTIL16** (2 - 8' pcs)
- MDENTIL24** (3 - 8' pcs)

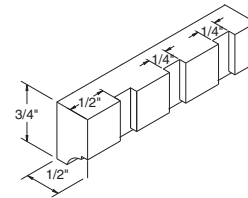

NOTES ✓

- ▶ Moulding Rope dimension: 3/4" x 3/8" x 8'.
- ▶ Moulding Base Shoe dimension: 5/8" x 4 1/4" x 8'.

DESIGN SOLUTIONS

- ▶ Moulding Rope can be used with Insert Crown Moulding.



Moulding Rope

- MROPE8** (1 - 8' pcs)
- MROPE16** (2 - 8' pcs)
- MROPE24** (3 - 8' pcs)

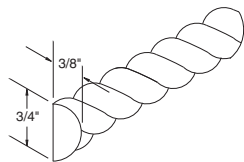

Moulding Base Shoe

- MBS8** (1 - 8' pcs)
- MBS16** (2 - 8' pcs)
- MBS24** (3 - 8' pcs)

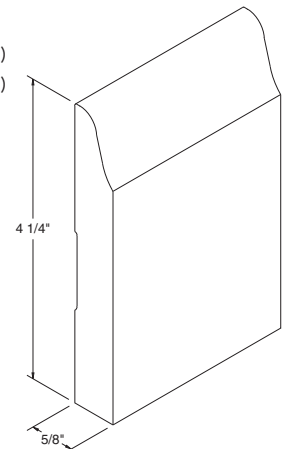

Fillers

- FBC3X3**
- F330**
- F331**
- F342**
- F631**
- F642**
- F380**
- F392**
- F680**
- F692**
- FF331**
- FF396**

- FFL331** *New*
- FFL396** *New*
- FFL631** *New*
- FFL696** *New*
- BLVDF331 (pair)** *New*
- F531A45 (pair)**
- TKF3**

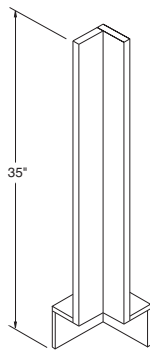

FBC3X3

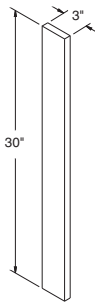

F330



F331 & F631

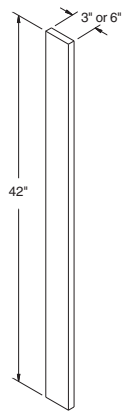

F342 & F642

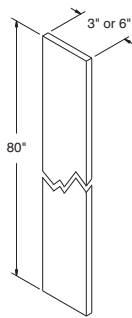

F380 & F680

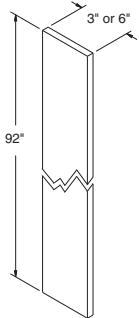

F392 & F692

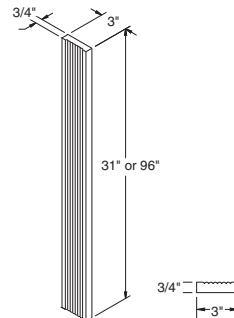

FF331 & FF396
(3" Reeded Fillers)

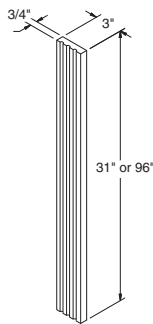

FFL331 &
FFL396
(3" Fluted Fillers)

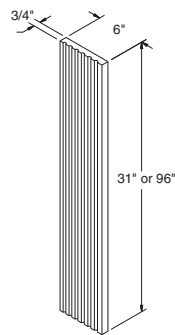

FFL631 &
FFL696
(6" Fluted Fillers)

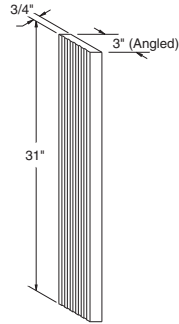

BLVDF331 (pair)
(Angled Fluted/
Plain Filler)

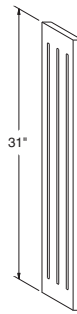

F531A45 (pair)
(Decorative Angled
Fluted/Plain Filler)



TKF3

NOTES

- ▶ FBC3X3 Overlays available for Nantucket, Eastland, Ellsworth, Wentworth, Sutherland, and Durham. Must order separately under OL3X3 code.
- ▶ All Fillers finished on front and two long edges, except for F531A45 and BLVDF331 which are finished on both sides and both long edges.
- ▶ All Fillers are 3/4" thick.
- ▶ FBC3X3 - Base Corner Filler with Toekick attached.
- ▶ F330 - 3" wide Filler.
- ▶ F331 - 3" wide Filler.
- ▶ F342 - 3" wide Filler.
- ▶ F631 - 6" wide Filler.
- ▶ F642 - 6" wide Filler.
- ▶ F380 - 3" wide Utility Filler.
- ▶ F392 - 3" wide Utility Filler.
- ▶ F680 - 6" wide Filler.
- ▶ F692 - 6" wide Filler.
- ▶ FF331 - 3" wide Reeded Filler.
- ▶ FF396 - 3" wide Reeded Filler.
- ▶ FFL331 - 3" wide Fluted Filler.
- ▶ FFL396 - 3" wide Fluted Filler.
- ▶ FFL631 - 6" wide Fluted Filler.
- ▶ FFL696 - 6" wide Fluted Filler.
- ▶ BLVDF331 - 45° reversible angled Filler (fluted one side). Comes as a pair. Reversible, finished on back.
- ▶ F531A45 - 45° reversible decorative angled Filler (fluted one side). Comes as a pair. Trimmable 2" top and bottom. Reversible, finished on back.
- ▶ TKF3 - Toekick Filler. Order under style #010.



NOTES ✓

- ▶ The outside profile of the Overlay matches the outside door profile.
- ▶ 3/4" thick.
- ▶ Order under door style number (ex. Nantucket Antique #201, Eastland Autumn #552).
- ▶ Use OL3X3 for FBC3X3 Base Corner Filler.
- ▶ Use OL12 for 12" high Wall.
- ▶ Use OL14 for 14" high Wall.
- ▶ Use OL18 for 18" high Wall.
- ▶ Use OL24 for 24" high Wall.
- ▶ Use OL26 for 30" high Vanity.
- ▶ Use OL30 for 30" high Wall.
- ▶ Use OL31 for 35" high Base/Vanity.
- ▶ Use OL335 for PEPR335 Panels (page 151).
- ▶ Use OL36 for 36" high Wall.
- ▶ Use OL42 for 42" high Wall.
- ▶ Use OL80 for 84" high Utility.
- ▶ Use OL86 for 90" high Utility.
- ▶ Use OL92 for 96" high Utility.



Overlays

		Use For
OL3X3	2" x 30 1/8" & 2 3/4" x 30 1/8"	FBC3X3 Base Corner Filler
OL12	2 1/4" x 11 1/2"	12" High Wall
OL14	2 1/4" x 13 1/2"	14" High Wall
OL18	2 1/4" x 17 1/2"	18" High Wall
OL24	2 1/4" x 23 1/2"	24" High Wall
OL26	2 1/4" x 25 1/2"	30" High Vanity
OL30	2 1/4" x 29 1/2"	30" High Wall
OL31	2 1/4" x 30 1/8"	35" High Base/Vanity
OL335	2 1/4" x 30 1/8"	PEPR335 Panels (page 151)
OL36	2 1/4" x 35 1/2"	36" High Wall
OL42	2 1/4" x 41 1/2"	42" High Wall
OL80	2 1/4" x 79 1/2"	84" High Utility
OL86	2 1/4" x 85 1/2"	90" High Utility
OL92	2 1/4" x 91 1/2"	96" High Utility

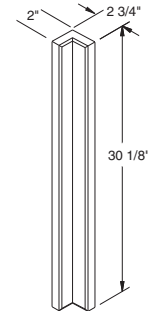
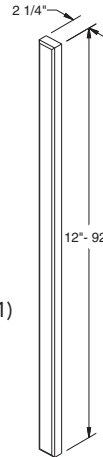

* Overlays are only available in Eastland, Ellsworth, Nantucket, Durham, Sutherland, and Wentworth.

MOULDINGS AND TRIM

NOTES ✓

- ▶ SPTRINGEND is sold in pairs and are trimmable up to 5" each.



Split Turnings

REED96
SPOOL96
SPTRINGEND

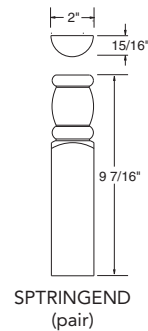
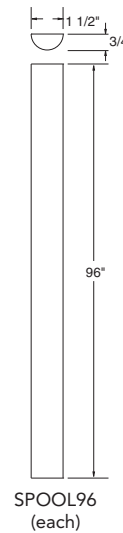
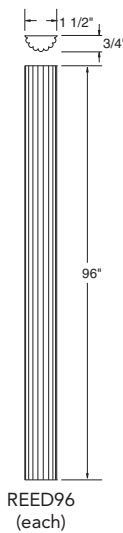

Decorative Legs

French Leg

FRNLEG

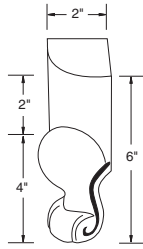

Island Leg

ISLEGSQ

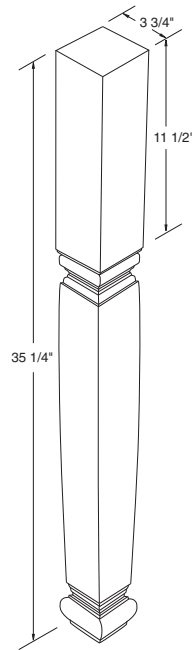

NOTES ✓

- ▶ Trimmable.
- ▶ FRNLEG available in cherry, maple, and white/antique finishes only.
- ▶ ISLEGSQ available in all finishes.



Decorative Legs (continued)

Tapered Leg

TAPLEG

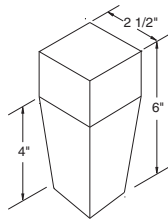

Rosette

FFROS3X3

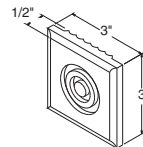

NOTES ✓

- Tapered Leg
- ▶ Trimmable.
 - ▶ TAPLEG available in cherry, maple, and white/antique finishes only.
- Rosette
- ▶ Grooved to fit FFs.



NOTES ✓

- ▶ In order to support substantial weight, Corbels must be properly installed with the attachment screws driven into a stud wall.



Small Corbel

SMCORBEL

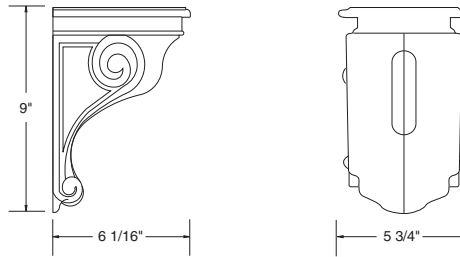

NOTES ✓

- ▶ In order to support substantial weight, Corbels must be properly installed with the attachment screws driven into a stud wall.



Large Corbel

LGCORBEL

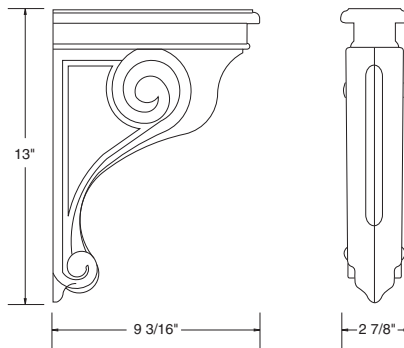

NOTES ✓

- ▶ Finished on all sides (reversible).
- ▶ Not intended to be used as a freestanding shelf support.
- ▶ VCORBEL sold in pairs, one left and one right.
- ▶ VCORBEL is 3/4" thick.

DESIGN SOLUTIONS

- ▶ Use VCORBEL with English Country Valances.



Valance Corbels

VCORBEL

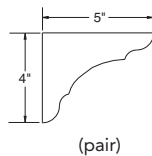

VCORBEL11

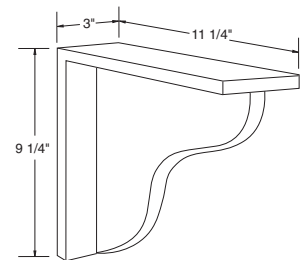

Acanthus Overlay

ACOVLY

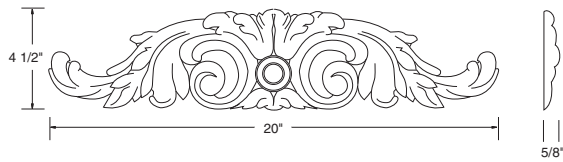

NOTES ✓

▶ Available in all finishes.

DESIGN SOLUTIONS

▶ Can be added to Wood Hood for decorative embellishment. (See page 149).

Acanthus Ornament

ACO

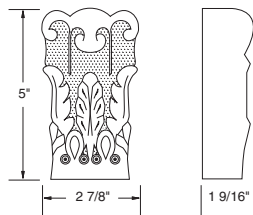

NOTES ✓

▶ Available in all finishes.



Valances Scalloped, 4 5/8" High

**V549SC
V561SC
V573SC**



	Length
V549SC	49"
V561SC	61"
V573SC	73"

NOTES ✓

- ▶ 3/4" thick.
- ▶ Valances not finished on back.
- ▶ Trimmable up to 1/2" on each side: 1" overall.



NOTES ✓

- ▶ 3/4" thick.
- ▶ Valances not finished on back.



Valances Arch, 5" High

- V525RA**
- V531RA**
- V537RA**
- V543RA**
- V549RA**
- V561RA**
- V573RA**



	A =	Length
V525RA	4 1/4"	25"
V531RA	4 1/4"	31"
V537RA	4 1/4"	37"
V543RA	4 1/2"	43"
V549RA	4 1/2"	49"
V561RA	6"	61"
V573RA	6 3/4"	73"

MOULDINGS AND TRIM

NOTES ✓

- ▶ 3/4" thick.
- ▶ Valances not finished on back.



Valances Straight, 5" High or 8 7/8" High

- V531ST**
- V537ST**
- V540ST**
- V543ST**
- V546ST**
- V549ST**
- V561ST**
- V573ST**
- V937ST**
- V949ST**
- V961ST**
- V973ST**



V531ST-V573ST



V937ST-V973ST

	Length
V531ST	31"
V537ST	37"
V540ST	40"
V543ST	43"
V546ST	46"
V549ST	49"
V561ST	61"
V573ST	73"
V937ST	37"
V949ST	49"
V961ST	61"
V973ST	73"

NOTES ✓

- ▶ 3/4" thick.
- ▶ Valances not finished on back.



Valances English Country, 5" High

- V525EC**
- V537EC**
- V549EC**
- V585EC**



	Cut Out	Length
V525EC	8 15/16"	25"
V537EC	16 7/16"	37"
V549EC	31 3/8"	49"
V585EC	46 1/4"	85"

Frieze Rail, 4^{3/4}" High

FR513
FR516
FR519
FR522
FR528
FR534
FR540

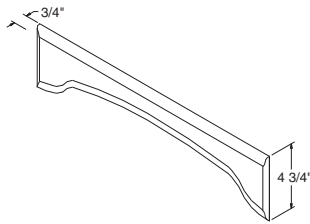

NOTES ✓

- ▶ Frieze Rail is attached to face frame with angle brackets (included).
- ▶ Outside edge profiled.
- ▶ FR513 – for 15" wide WOL/BOL wall cabinets.
- ▶ FR516 – for 18" wide WOL/BOL wall cabinets.
- ▶ FR519 – for 21" wide WOL/BOL wall cabinets.
- ▶ FR522 – for 24" wide WOL and Bookcase cabinets.
- ▶ FR528 – for 30" wide WOL and Bookcase cabinets.
- ▶ FR534 – for 36" wide WOL and Bookcase and Activity Center cabinets.
- ▶ FR540 – for 42" wide Bookcase and Activity Center cabinets.



Tapered Wood Hood (with Liner), 24" High

TWH30

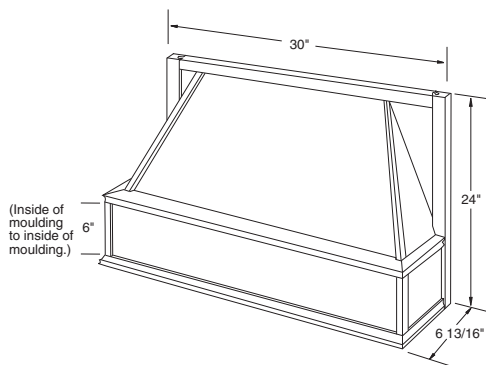

TWH36

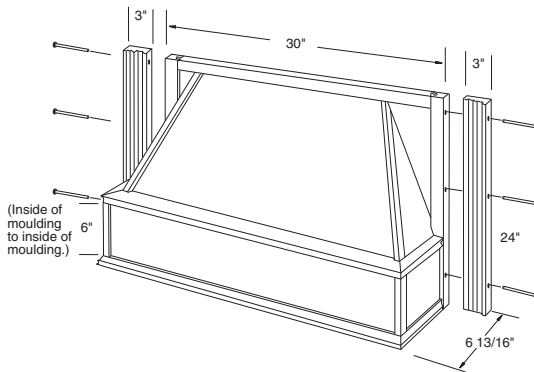

NOTES ✓

- ▶ White metal liner included with all Wood Hoods and cannot be ordered separately.
- ▶ Install Wood Hoods between adjoining 12" deep cabinets (15" deep cabinets are not recommended).
- ▶ Check your local building code for installation heights above the range.
- ▶ TWH36 has two plain/fluted stiles with metal wings included to extend Hood to 36" width.
- ▶ Blower unit not included. See page 150 for TWHBLOWER390 and TWHCONVKIT.

DESIGN SOLUTIONS

- ▶ Wood Hoods are designed to be used with Acanthus Overlay (ACOVLY).



NOTES ✓

- ▶ 6" diameter vent.
- ▶ One year warranty.
- ▶ Two 40-watt candelabra lights, (not included), and three fan setting levels.
- ▶ CFM Rating – Maximum 390 CFM (cubic feet per minute).
- ▶ Order under style #010.
- ▶ Manufacturer recommends 24"-30" clearance between cooking surface and blower unit.
- ▶ Filter not included.



Tapered Wood Hood Blower

TWHBLOWER390

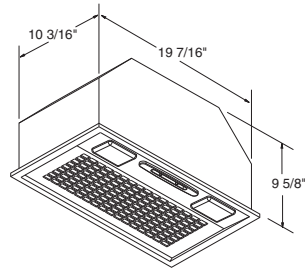

NOTES ✓

- ▶ Kit allows TWHBLOWER390 to be vented internally.
- ▶ Order under style #010.
- ▶ Kit includes: One 21" x 7" round pipe, 1 adjustable collar, 1 white metal soffit grille, 1 adjustable boot, a 7" to 6" reducer, and FILTER390.
- ▶ FILTER390 also available to order separately for replacements.



Tapered Wood Hood Conversion Kit

TWHCONVKIT

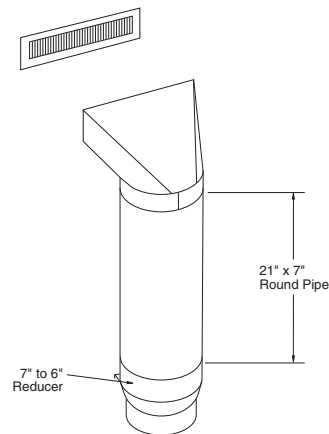

NOTES ✓

- ▶ Replacement filters for use with TWHCONVKIT.



Filter390

FILTER390

Panels

PDWP
PEPR1.535
PEPR335
PEPRPLY1.535 *
PEPRPLY335 *
PREF2384
PREF2396
PREPRP1.584
PREPRP1.596
PREPR33096
PSFEP

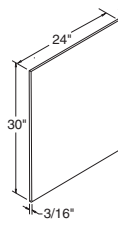

PDWP

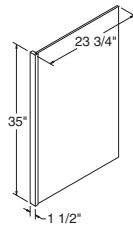

PEPR1.535
PEPRPLY1.535

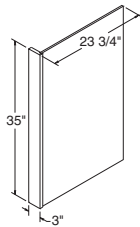

PEPR335
PEPRPLY335

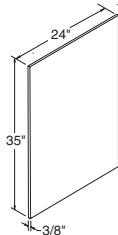

PSFEP

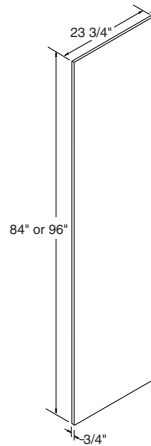

PREF2384
PREF2396

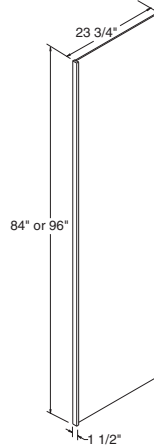

PREPRP1.584
PREPRP1.596

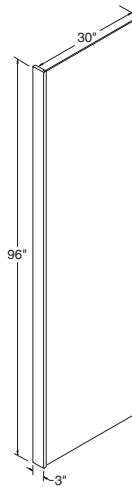

PREPR33096

NOTES

▶ PEPR overlays available in Durham, Nantucket, Eastland, Wentworth, and Sutherland. Must order separately under OL335 product code. (See page 144.)

*PEPRPLY1.535 and PEPRPLY335 not available in white or antique finishes.

† PREPRP1.584 and PREPRP1.596 will be laminate when ordered in white and antique styles.



Panel	Description	Size (T x W x H)	Edge Finish	Color Side 1	Color Side 2	Finish
PDWP	Dishwasher Front Panel	3/16" x 24" x 30"	None	Exterior	Raw	Veneer
PEPR1.535	Aristex® 3/8" End Panel w/1 1/2" Stile	1 1/2" x 23 3/4" x 35"	Front Long	Exterior	Interior	Laminate
PEPR335	Aristex® 3/8" End Panel w/3" Stile	3" x 23 3/4" x 35"	Front Long	Exterior	Interior	Laminate
PEPRPLY1.535 *	Plywood 3/8" End Panel w/1 1/2" Stile	1 1/2" x 23 3/4" x 35"	Front Long	Exterior	Interior	Veneer
PEPRPLY335 *	Plywood 3/8" End Panel/ Stile Complete	3" x 23 3/4" x 35"	Front Long	Exterior	Interior	Veneer
PREF2384	Veneered Furniture Board Plywood Refrigerator End Panel	3/4" x 23 3/4" x 84"	1 Long	Exterior	Exterior	Veneer
PREF2396	Veneered Furniture Board Plywood Refrigerator End Panel	3/4" x 23 3/4" x 96"	1 Long	Exterior	Exterior	Veneer
PREPRP1.584 †	Plywd. 3/8" Refrigerator End Panel w/1 1/2" Stile	1 1/2" x 23 3/4" x 84"	Front Long	Exterior	Exterior	Veneer
PREPRP1.596 †	Plywd. 3/8" Refrigerator End Panel w/1 1/2" Stile	1 1/2" x 23 3/4" x 96"	Front Long	Exterior	Exterior	Veneer
PREPR33096	Veneered Furniture Board Refrigerator 3/4" End Panel w/3" Stile	3" x 30" x 96"	Front Long	Exterior	Exterior	Veneer
PSFEP	Aristex® Sink End Panel	3/8" x 24" x 35"	None	Exterior	Interior	Laminate

NOTES ✓

*PP9635 is not available in white or antique finishes.



Stock Panels

- BP4896**
- PA4836**
- PA4896**
- PP9635 ***
- P4836**
- P4896**

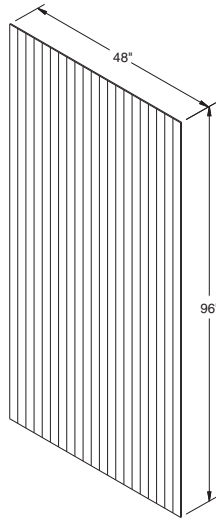

BP4896

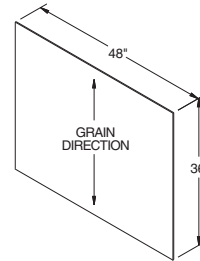

PA4836
P4836

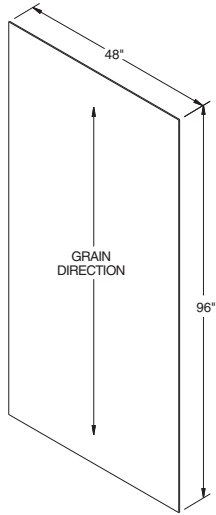

PA4896
P4896

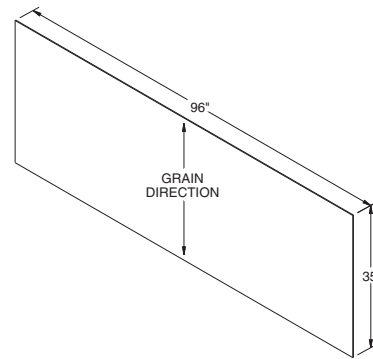

PP9635

Panel	Description	Size (T x W x H)	Edge Finish	Color Side 1	Color Side 2	Finish
BP4896	Beadboard Panel	3/16" x 48" x 96"	None	Exterior	Raw	Veneer
PA4836	Stock Panel - Aristex® Laminate	1/4" x 48" x 36"	None	Exterior	Raw	Laminate
PA4896	Stock Panel - Aristex® Laminate	1/4" x 48" x 96"	None	Exterior	Raw	Laminate
PP9635 *	Stock Panel - Veneer	3/16" x 96" x 35"	None	Exterior	Raw	Veneer
P4836	Stock Panel - Veneer	3/16" x 48" x 36"	None	Exterior	Raw	Veneer
P4896	Stock Panel - Veneer	3/16" x 48" x 96"	None	Exterior	Raw	Veneer

Veneer End Panels

- EP1130** (2/ctn.)
- EP1142** (2/ctn.)
- EP1430** (2/ctn.)
- EP1442** (2/ctn.)
- EP2335** (2/ctn.)
- EP2384** (2/ctn.)
- EP2396** (2/ctn.)

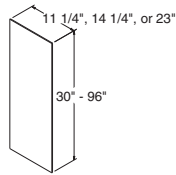

NOTES ✓

- ▶ End panels are shipped two per carton.
- ▶ EP1430 and EP1442 are sized for 15" deep cabinets.



Panel	Description	Size (T x W x H)	Edge Finish	Color Side 1	Color Side 2	Finish
EP1130	Wall End Panel for 12" Depth	3/16" x 11 1/4" x 30"	None	Exterior	Raw	Veneer
EP1142	Wall End Panel for 12" Depth	3/16" x 11 1/4" x 42"	None	Exterior	Raw	Veneer
EP1430	Wall End Panel for 15" Depth	3/16" x 14 1/4" x 30"	None	Exterior	Raw	Veneer
EP1442	Wall End Panel for 15" Depth	3/16" x 14 1/4" x 42"	None	Exterior	Raw	Veneer
EP2335	Base End Panel	3/16" x 23" x 35"	None	Exterior	Raw	Veneer
EP2384	Utility End Panel	3/16" x 23" x 84"	None	Exterior	Raw	Veneer
EP2396	Utility End Panel	3/16" x 23" x 96"	None	Exterior	Raw	Veneer

Decorative Panels

- DBEP ***
- DBEPFH-12 ***
- DDWP**
- DPBEP ***
- DUEP84 ***
- DUEP90 ***
- DUEP96 ***
- DVEP ***
- DVEP35 ***
- DWEP30 ***
- DWEP36 ***
- DWEP42 ***
- DWEP1530 ***
- DWEP1536 ***
- DWEP1542 ***

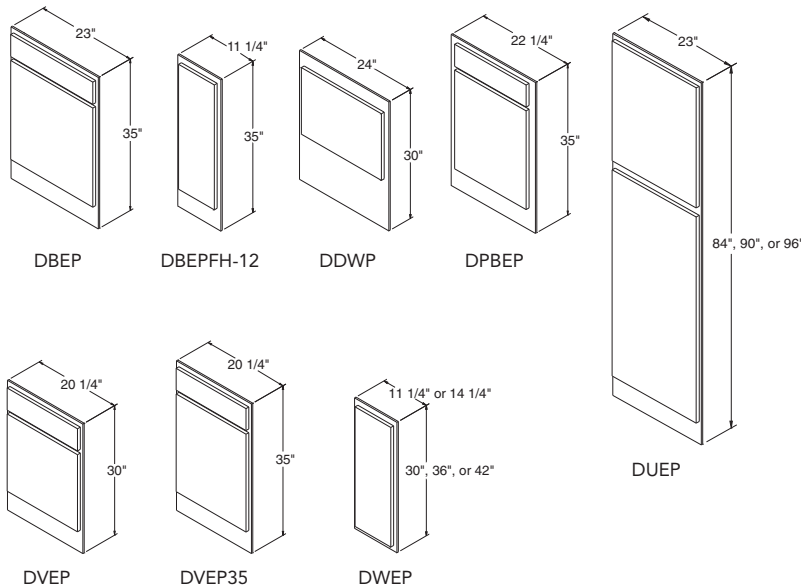

NOTES ✓

- ▶ DDWP includes one door, one Panel 24" x 30", and screws for installation. Shipped unassembled.
 - ▶ DBEP and DPBEP include one door and one drawer front on an EP2335 Veneer End Panel and five screws for mounting.
 - ▶ DUEP includes two doors and one EP__ Veneer End Panel, and screws for assembly. Shipped unassembled.
 - ▶ DUEP will have three doors on miter styles (Landen, Grayson, Saybrooke, Wentworth, and Sutherland.)
 - ▶ DVEP includes one door, one drawer front, and one Panel 24" x 30", and screws for assembly. Shipped unassembled.
 - ▶ DWEP parts include one door and an EP__ Veneer End Panel and four screws for mounting. Shipped assembled.
 - ▶ Actual sizes of doors and drawer fronts used will vary slightly by style. For exact dimensions, refer to parts dimension guide.
 - ▶ Panel construction is the same for Standard, Select, and Ply Select.
- *Specify L or R on full overlay styles for all Decorative Panels except DDWP.



Panel	Description	Size (T x W x H)	Edge Finish	Color Side 1	Color Side 2	Finish
DBEP	Decorative Base End	3/16" x 23" x 35"	None	Exterior	Raw	Veneer
DBEPFH-12	Decorative Base End for 12" Depth	3/16" x 11 1/4" x 35"	None	Exterior	Raw	Veneer
DDWP	Decorative Dishwasher Front	3/16" x 24" x 30"	None	Exterior	Raw	Veneer
DPBEP	Decorative Peninsula Base End	3/16" x 22 1/4" x 35"	None	Exterior	Raw	Veneer
DUEP84	Decorative Utility End	3/16" x 23" x 84"	None	Exterior	Raw	Veneer
DUEP90	Decorative Utility End	3/16" x 23" x 90"	None	Exterior	Raw	Veneer
DUEP96	Decorative Utility End	3/16" x 23" x 96"	None	Exterior	Raw	Veneer
DVEP	Decorative Vanity End	3/16" x 20 1/4" x 30"	None	Exterior	Raw	Veneer
DVEP35	Decorative Vanity End	3/16" x 20 1/4" x 35"	None	Exterior	Raw	Veneer
DWEP30	Decorative Wall End	3/16" x 11 1/4" x 30"	None	Exterior	Raw	Veneer
DWEP36	Decorative Wall End	3/16" x 11 1/4" x 36"	None	Exterior	Raw	Veneer
DWEP42	Decorative Wall End	3/16" x 11 1/4" x 42"	None	Exterior	Raw	Veneer
DWEP1530	Decorative Wall End for 15" Depth	3/16" x 14 1/4" x 30"	None	Exterior	Raw	Veneer
DWEP1536	Decorative Wall End for 15" Depth	3/16" x 14 1/4" x 36"	None	Exterior	Raw	Veneer
DWEP1542	Decorative Wall End for 15" Depth	3/16" x 14 1/4" x 42"	None	Exterior	Raw	Veneer

NOTES ✓

- ▶ All End Panel Columns feature an attached 3/8" laminate finished end panel.
- ▶ EPCWFLs are reversible and designed for use in Wall applications.
- ▶ EPCBFLs are designed for use in Base applications.
- ▶ EPCTFLs are designed for use in Tall applications.
- ▶ End Panel Columns are available in Cherry, Maple, and White/Antique finishes only.

*Specify L or R to indicate panel location.



End Panel Columns, Fluted

Wall

- EPCWFL24** *New*
- EPCWFL30** *New*
- EPCWFL42** *New*

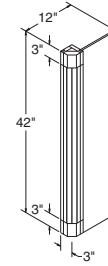
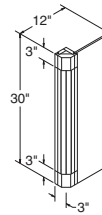
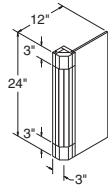

Base

- EPCBFL31** * *New*
- EPCBFL35** * *New*

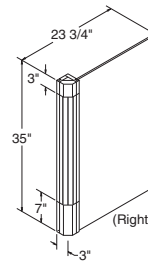
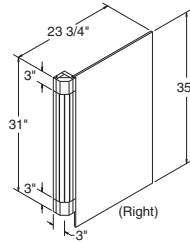

Tall

- EPCTFL84** * *New*
- EPCTFL90** * *New*
- EPCTFL96** * *New*

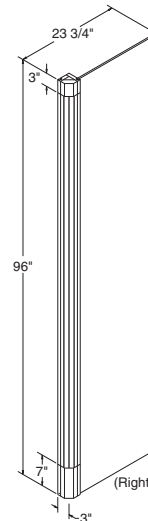
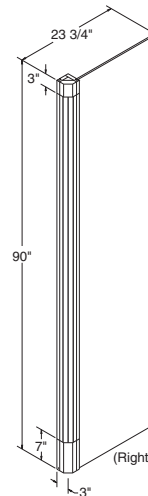
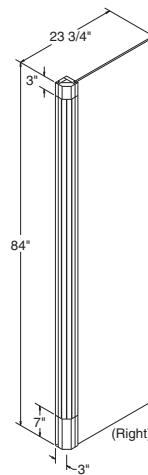

End Panel Columns, Reeded

Wall

EPCWRE24 *New*
EPCWRE30 *New*
EPCWRE42 *New*

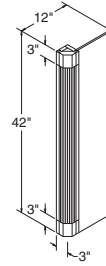
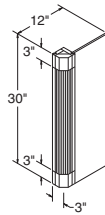
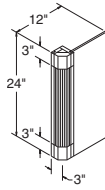

NOTES ✓

- ▶ All End Panel Columns feature an attached 3/8" laminate finished end panel.
 - ▶ EPCWREs are reversible and designed for use in Wall applications.
 - ▶ EPCBREs are designed for use in Base applications.
 - ▶ EPCTREs are designed for use in Tall applications.
 - ▶ End Panel Columns are available in Cherry, Maple, and White/Antique finishes only.
- ★Specify L or R to indicate panel location.



Base

EPCBRE31 ★ *New*
EPCBRE35 ★ *New*

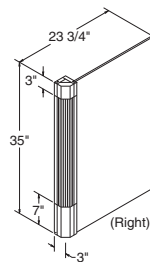
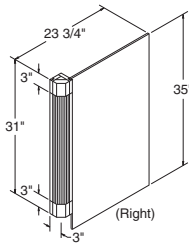

Tall

EPCTRE84 ★ *New*
EPCTRE90 ★ *New*
EPCTRE96 ★ *New*

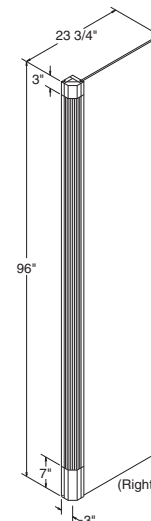
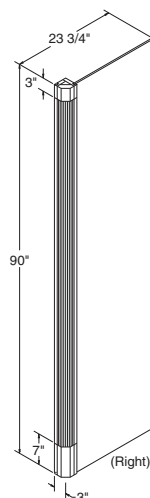
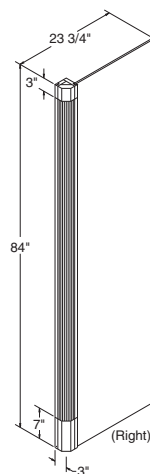

NOTES ✓

- ▶ All End Panel Columns feature an attached 3/8" laminate finished end panel.
- ▶ EPCWRDs are reversible and designed for use in Wall applications.
- ▶ EPCBRDs are designed for use in Base applications.
- ▶ EPCTRDs are designed for use in Tall applications.
- ▶ End Panel Columns are available in Cherry, Maple, and White/Antique finishes only.

*Specify L or R to indicate panel location.



End Panel Columns, Round

Wall

- EPCWRD24** *New*
- EPCWRD30** *New*
- EPCWRD42** *New*

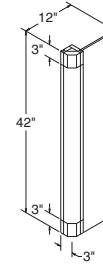
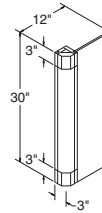
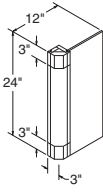

Base

- EPCBRD31** * *New*
- EPCBRD35** * *New*

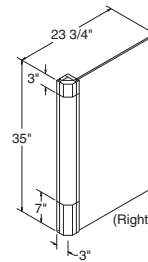
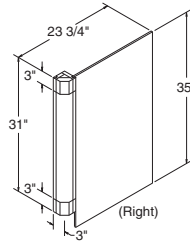

Tall

- EPCTRD84** * *New*
- EPCTRD90** * *New*
- EPCTRD96** * *New*

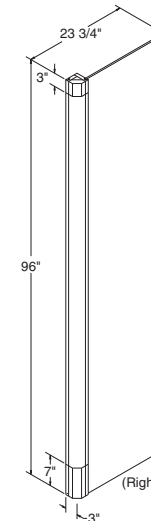
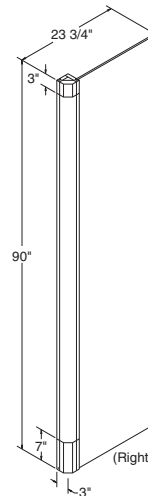
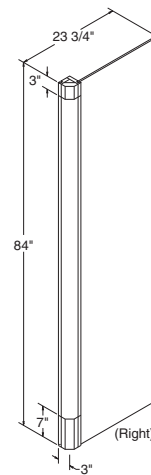

Range Panel, 35" High

RP30

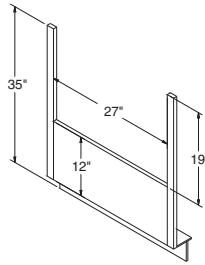

NOTES ✓

- ▶ Rail, Panel, and Toekick.
- ▶ 27" opening.

DESIGN SOLUTIONS

- ▶ Use drawer front to cover bottom portion of panel.



Toekick

**TOEKICK
TOEKICK8**

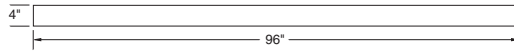

NOTES ✓

- ▶ Toekick dimension: 1/4" x 4" x 96"
- ▶ TOEKICK – 4 - 96" pieces, 1/4" thick, and 4" wide.
- ▶ TOEKICK8 – 1 - 96" piece, 1/4" thick, and 4" wide.



Item	Description	Size (T x W x H)	Edge Finish	Color Side 1	Color Side 2	Finish
TOEKICK	Aristex® Toekick	1/4" x 4" x 96"	None	Exterior	Raw	Laminate
TOEKICK8	Aristex® Toekick	1/4" x 4" x 96"	None	Exterior	Raw	Laminate

Toekick Cap

TKC

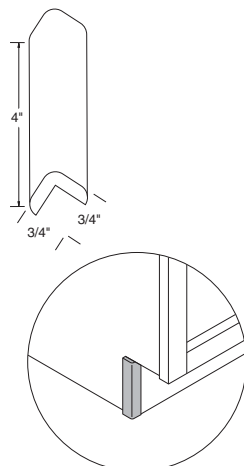

NOTES ✓

- ▶ TKC dimension: 3/4" x 4" x 3/4"
- ▶ TKC recommended for use with recessed toekick construction cabinets.
- ▶ Sold in pairs.

